

PCHC 2018 Pflicht- Beklebensplan



**Porsche Club
Historic Challenge**



Startnummerntafel –
rechte und linke Tür

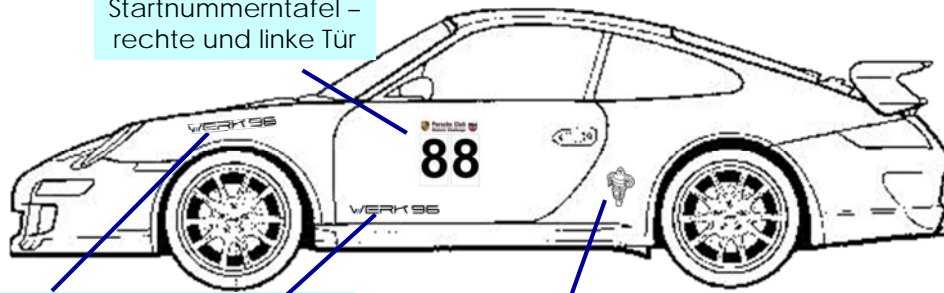

Werk 96 Logo - vorderer Kotflügel oder
Tür über Schweller – links und rechts

Michelin Bibendum – optional hinter linker und rechter Tür

Startnummer gelb -
Gelb Frontscheibe
oben rechts in
Fahrtrichtung

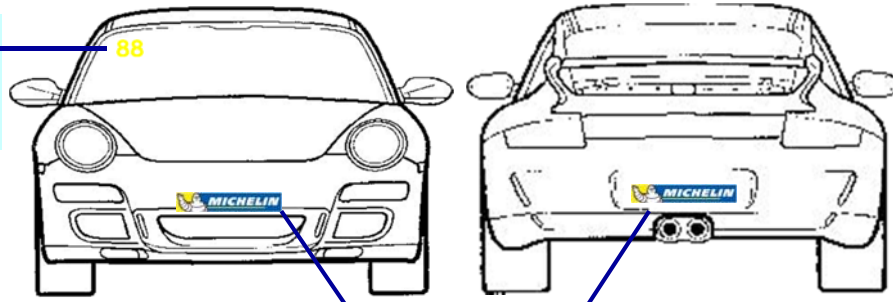

Michelin Logo – Kennzeichenbereich – vorne und hinten

PCHC 2018 Beklebens-Elemente



**Porsche Club
Historic Challenge**



■ Starttafel mit Startnummer

- schwarz, Tür links und rechts
- Tafel 33 cm * 33 cm, Nummer Höhe 22 cm



88

■ Startnummer

- Gelb Frontscheibe oben rechts in Fahrtrichtung
- Höhe 10 cm

■ Michelin Logo Sport

- Vorderes und hinteres Kennzeichen
- Breite 50 cm



■ Michelin Bibendum

- Optional Hinter den Türen, Höhe 15, 20 oder 25 cm

■ Werk 96 Logo

- Im Bereich vorderer Kotflügel
- oder Tür über Schweller, Breite min. 40 cm

WERK 96

PCHC 2014 Muster zum Beklebensplan



Porsche Club
Historic Challenge



■ Front



■ Seite



■ Heck



Porsche Club
Historic Challenge

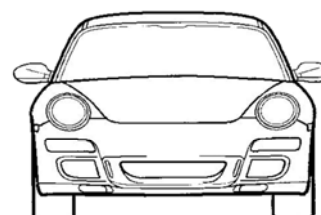
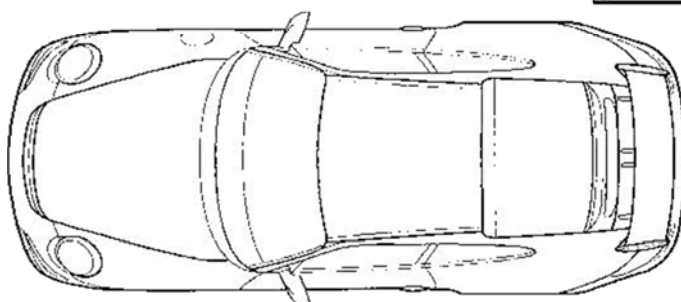
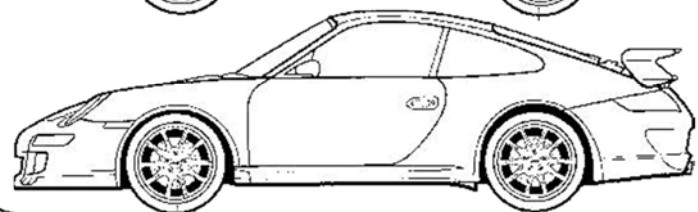
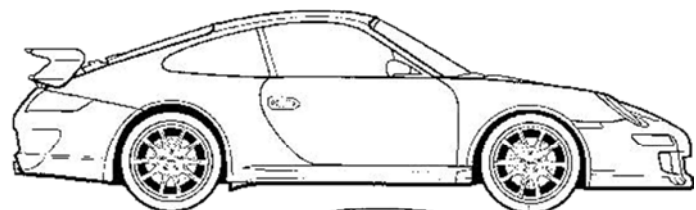
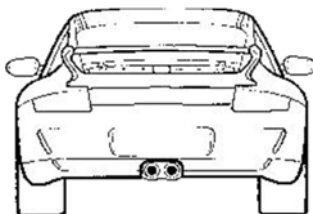

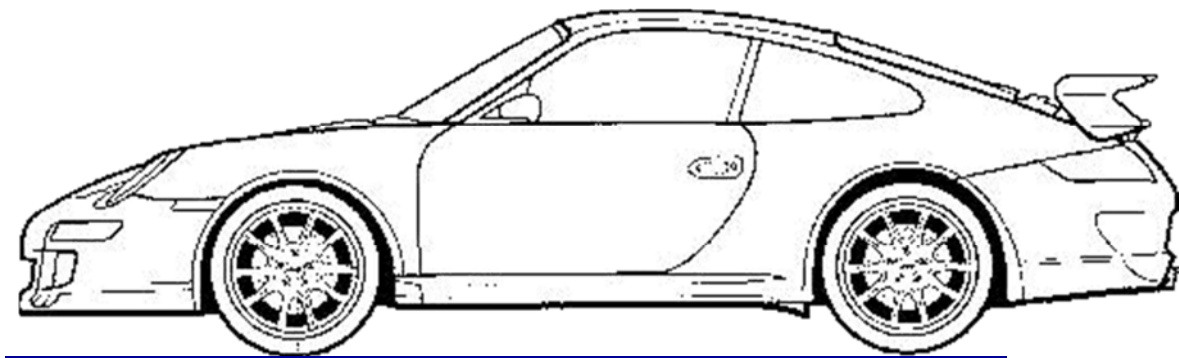
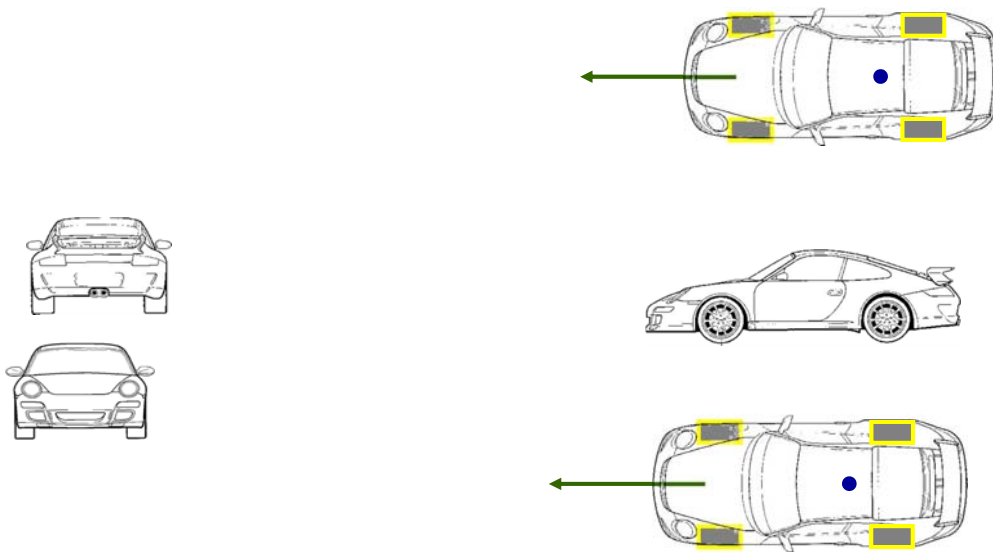

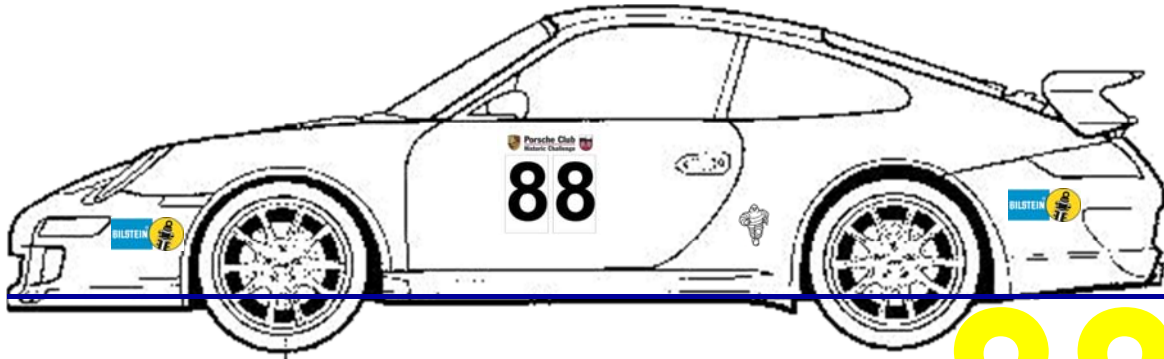

88